

Features

- 130MHz 3dB bandwidth ($A_V=+2$)
- 180MHz 3dB bandwidth ($A_V=+1$)
- 0.01% differential gain, $R_L=500\Omega$
- 0.01° differential phase, $R_L=500\Omega$
- Low supply current, 8.5mA
- Wide supply range, $\pm 2V$ to $\pm 15V$
- 80mA output current (peak)
- Low cost
- 1500V/ μs slew rate
- Input common mode range to within 1.5V of supplies
- 35ns settling time to 0.1%

Applications

- Video amplifiers
- Cable drivers
- RGB amplifiers
- Test equipment amplifiers
- Current to voltage converters

Ordering Information

Part No.	Package	Tape & Reel	Outline#
EL2160CN	8-Pin PDIP	-	MDP0031
EL2160CS-T7	8-Pin SO	7"	MDP0027
EL2160CS-T13	8-Pin SO	13"	MDP0027
EL2160CM	16-Pin SO (0.300")	-	MDP0027
EL2160CM-T13	16-Pin SO (0.300")	13"	MDP0027

General Description

The EL2160C is a current feedback operational amplifier with -3dB bandwidth of 130MHz at a gain of +2. Built using the Elantec proprietary monolithic complementary bipolar process, this amplifier uses current mode feedback to achieve more bandwidth at a given gain than a conventional voltage feedback operational amplifier.

The EL2160C is designed to drive a double terminated 75 Ω coax cable to video levels. Differential gain and phase are excellent when driving both loads of 500 Ω (<0.01%/<0.01°) and double terminated 75 Ω cables (0.025%/0.1°).

The amplifier can operate on any supply voltage from 4V ($\pm 2V$) to 33V ($\pm 16.5V$), yet consume only 8.5mA at any supply voltage. Using industry-standard pinouts, the EL2160C is available in 8-pin PDIP and SO packages, as well as a 16-pin SO (0.300") package. All are specified for operation over the full -40°C to +85°C temperature range. For dual and quad applications, please see the EL2260C/EL2460C datasheet.

Connection Diagrams

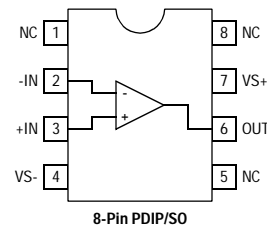
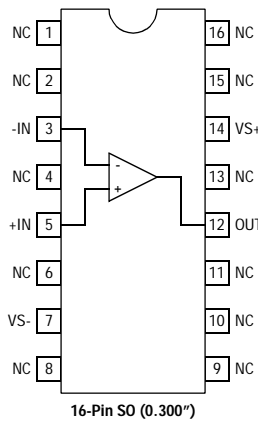

Note: All information contained in this data sheet has been carefully checked and is believed to be accurate as of the date of publication; however, this data sheet cannot be a "controlled document". Current revisions, if any, to these specifications are maintained at the factory and are available upon your request. We recommend checking the revision level before finalization of your design documentation.

EL2160C

180MHz Current Feedback Amplifier

Absolute Maximum Ratings ($T_A = 25^\circ\text{C}$)

Voltage between V_{S+} and V_{S-}	+33V	Operating Junction Temperature	
Voltage between +IN and -IN	$\pm 6\text{V}$	Plastic Packages	150°C
Current into +IN or -IN	10mA	Output Current	$\pm 50\text{mA}$
Internal Power Dissipation	See Curves	Storage Temperature Range	-65°C to +150°C
Operating Ambient Temperature Range	-40°C to +85°C		

Important Note:

All parameters having Min/Max specifications are guaranteed. Typ values are for information purposes only. Unless otherwise noted, all tests are at the specified temperature and are pulsed tests, therefore: $T_J = T_C = T_A$.

Open Loop DC Electrical Characteristics

$V_S = \pm 15\text{V}$, $R_L = 150\Omega$, $T_A = 25^\circ\text{C}$ unless otherwise specified.

Parameter	Description	Conditions	Temp	Limits			Unit
				Min	Typ	Max	
V_{OS}	Input Offset Voltage	$V_S = \pm 5\text{V}, \pm 15\text{V}$	25°C		2	10	mV
TC V_{OS}	Average Offset Voltage Drift ^[1]		Full		10		$\mu\text{V}/^\circ\text{C}$
+ I_{IN}	+Input Current	$V_S = \pm 5\text{V}, \pm 15\text{V}$	25°C		0.5	5	μA
- I_{IN}	-Input Current	$V_S = \pm 5\text{V}, \pm 15\text{V}$	25°C		5	25	μA
CMRR	Common Mode Rejection Ratio ^[2]	$V_S = \pm 5\text{V}, \pm 15\text{V}$	25°C	50	55		dB
-ICMR	-Input Current Common Mode Rejection ^[2]	$V_S = \pm 5\text{V}, \pm 15\text{V}$	25°C		0.2	5	$\mu\text{A}/\text{V}$
PSRR	Power Supply Rejection Ratio ^[3]		25°C	75	95		dB
-IPSR	-Input Current Power Supply Rejection ^[3]		25°C		0.2	5	$\mu\text{A}/\text{V}$
R_{OL}	Transimpedance ^[4]	$V_S = \pm 15\text{V}$ $R_L = 400\Omega$	25°C	500	2000		k Ω
		$V_S = \pm 5\text{V}$ $R_L = 150\Omega$	25°C	500	1800		k Ω
+ R_{IN}	+Input Resistance		25°C	1.5	3.0		M Ω
+ C_{IN}	+Input Capacitance		25°C		2.5		pF
CMIR	Common Mode Input Range	$V_S = \pm 15\text{V}$	25°C		± 13.5		V
		$V_S = \pm 5\text{V}$	25°C		± 3.5		V
V_O	Output Voltage Swing	$R_L = 400\Omega$ $V_S = \pm 15\text{V}$	25°C	± 12	± 13.5		V
		$R_L = 150\Omega$ $V_S = \pm 15\text{V}$	25°C		± 12		V
		$R_L = 150\Omega$ $V_S = \pm 5\text{V}$	25°C	± 3.0	± 3.7		V
		$V_S = \pm 5\text{V}$	25°C				V
I_{SC}	Output Short Circuit Current ^[5]	$V_S = \pm 5\text{V},$ $V_S = \pm 15\text{V}$	25°C	60	100	150	mA
I_S	Supply Current	$V_S = \pm 15\text{V}$	25°C		8.5	12.0	mA
		$V_S = \pm 5\text{V}$	25°C		6.4	9.5	mA

1. Measured from T_{MIN} to T_{MAX}
2. $V_{CM} = \pm 10\text{V}$ for $V_S = \pm 15\text{V}$ and $T_A = 25^\circ\text{C}$, $V_{CM} = \pm 3\text{V}$ for $V_S = \pm 5\text{V}$ and $T_A = 25^\circ\text{C}$
3. The supplies are moved from $\pm 2.5\text{V}$ to $\pm 15\text{V}$
4. $V_{OUT} = \pm 7\text{V}$ for $V_S = \pm 15\text{V}$, and $V_{OUT} = \pm 2\text{V}$ for $V_S = \pm 5\text{V}$
5. A heat sink is required to keep junction temperature below absolute maximum when an output is shorted

EL2160C

180MHz Current Feedback Amplifier

EL2160C

Closed Loop AC Electrical Characteristics

$V_S = \pm 15V$, $A_V = +2$, $R_F = 560\Omega$, $R_L = 150\Omega$, $T_A = 25^\circ C$ unless otherwise noted.

Parameter	Description	Conditions	Limits			Unit
			Min	Typ	Max	
BW	-3dB Bandwidth ^[1]	$V_S = \pm 15V$, $A_V = +2$		130		MHz
		$V_S = \pm 15V$, $A_V = +1$		180		MHz
		$V_S = \pm 5V$, $A_V = +2$		100		MHz
		$V_S = \pm 5V$, $A_V = +1$		110		MHz
SR	Slew Rate ^{[2][1]}	$R_L = 400\Omega$	1000	1500		V/ μs
		$R_F = 1K\Omega$, $R_G = 110\Omega$		1500		V/ μs
		$R_L = 400\Omega$				
t_r , t_f	Rise Time, Fall Time ^[1]	$V_{OUT} = \pm 500mV$		2.7		ns
t_{pd}	Propagation Delay ^[1]			3.2		ns
OS	Overshoot ^[1]	$V_{OUT} = \pm 500mV$		0		%
t_s	0.1% Settling Time ^[1]	$V_{OUT} = \pm 10V$ $A_V = -1$, $R_L = 1k$		35		ns
dG	Differential Gain ^{[3][1]}	$R_L = 150\Omega$		0.025		%
		$R_L = 500\Omega$		0.006		%
dP	Differential Phase ^{[3][1]}	$R_L = 150\Omega$		0.1		°
		$R_L = 500\Omega$		0.005		°

1. All AC tests are performed on a "warmed up" part, except for Slew Rate, which is pulse tested
2. Slew Rate is with V_{OUT} from +10V to -10V and measured at the 25% and 75% points
3. DC offset from -0.714V through +0.714V, AC amplitude 286mV_{p-p}, $f = 3.58MHz$

EL2160C

180MHz Current Feedback Amplifier

Typical Performance Curves

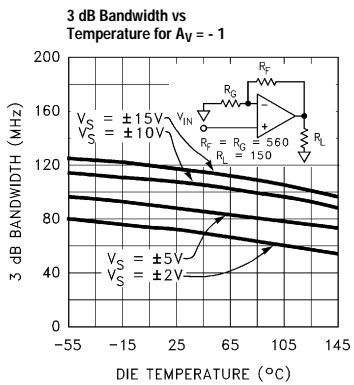
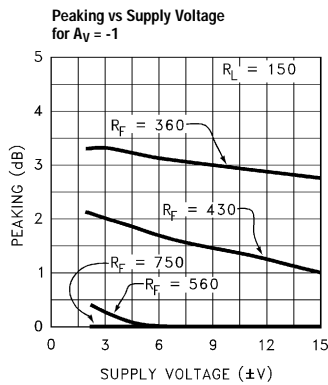
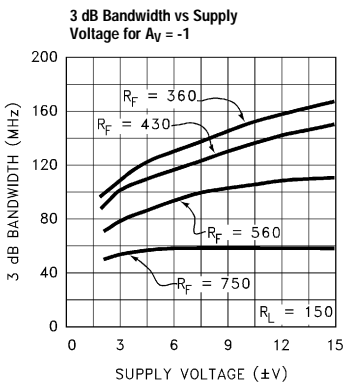
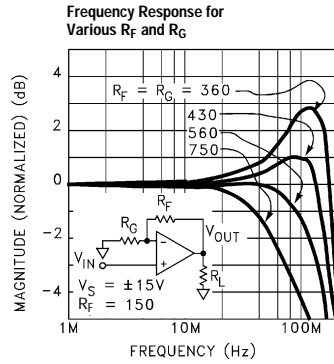
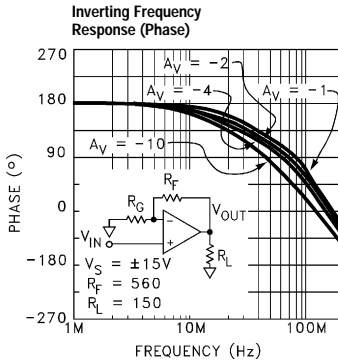
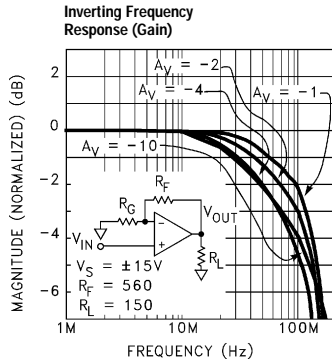
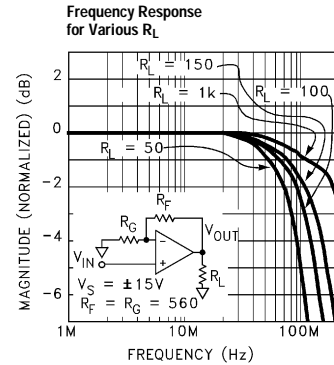
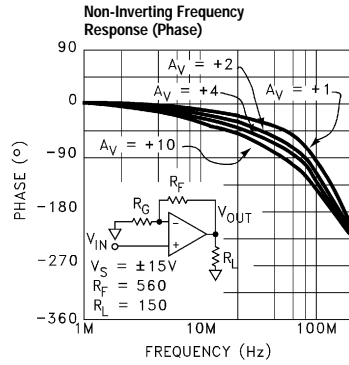
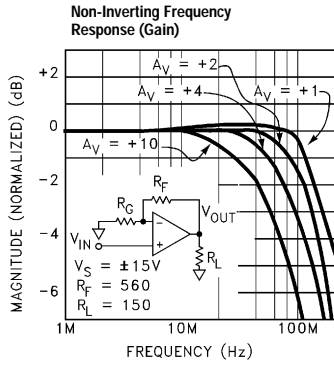

EL2160C

180MHz Current Feedback Amplifier

EL2160C

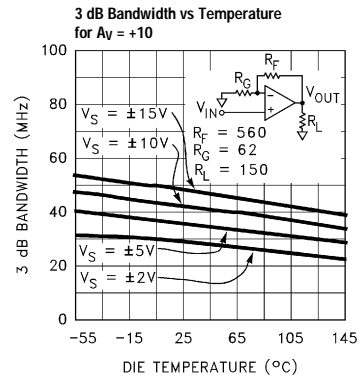
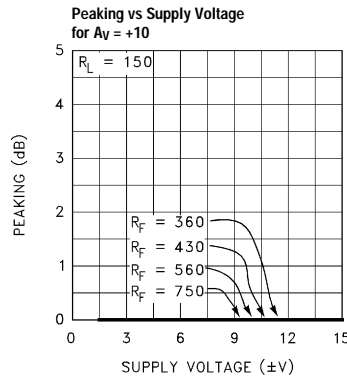
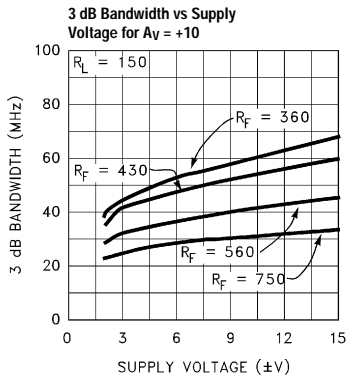
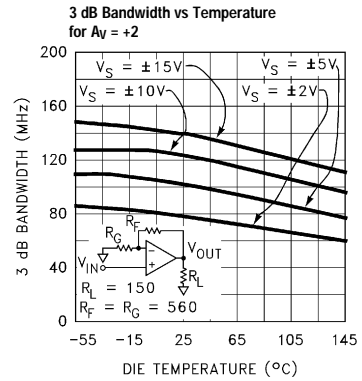
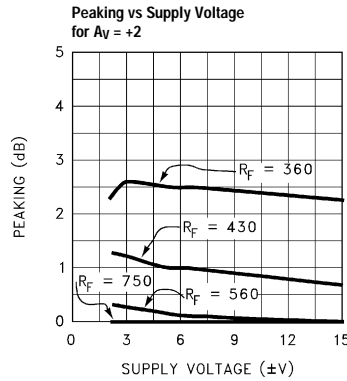
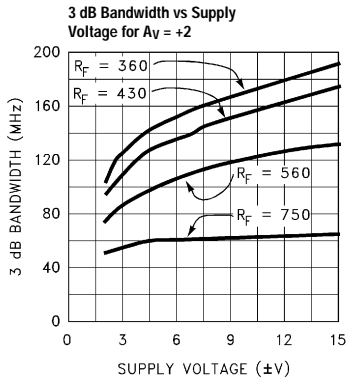
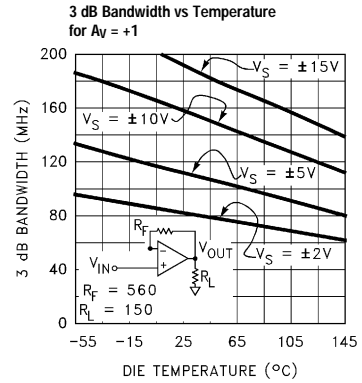
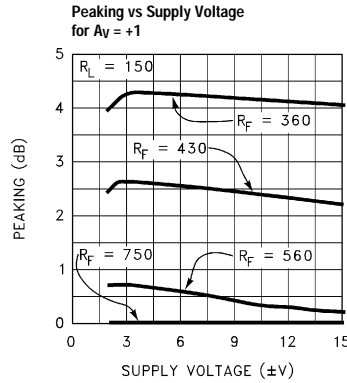
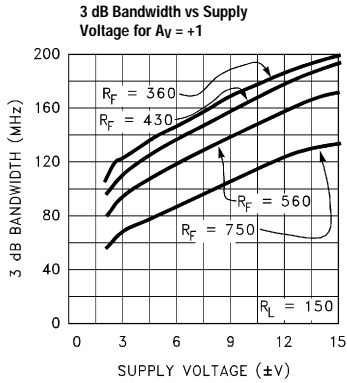

EL2160C

180MHz Current Feedback Amplifier

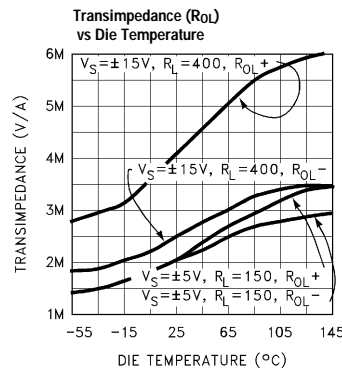
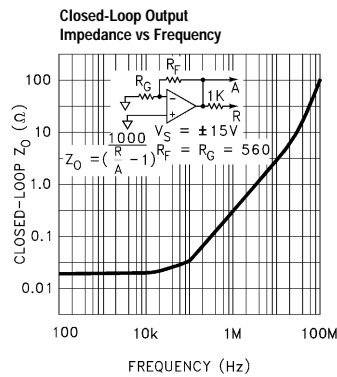
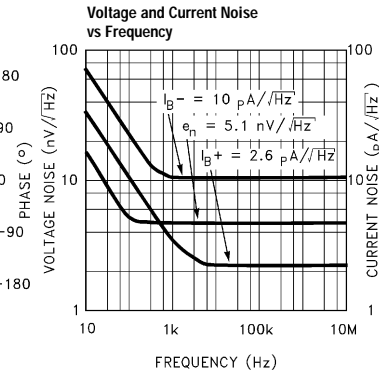
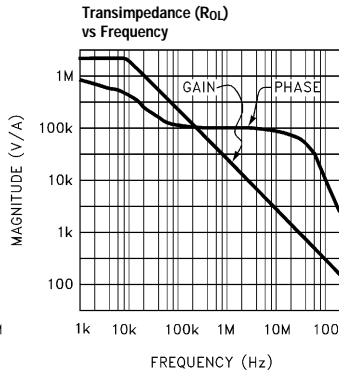
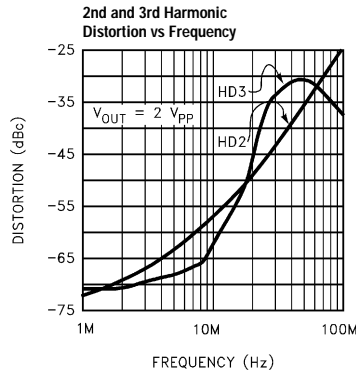
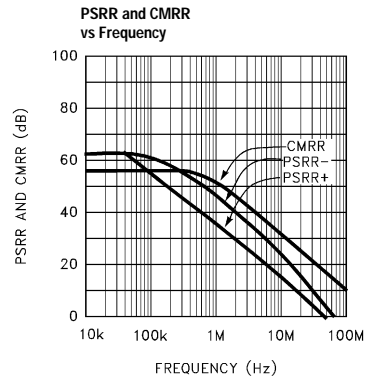
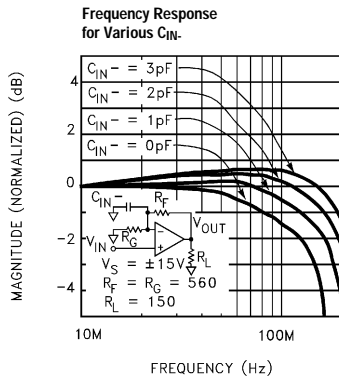
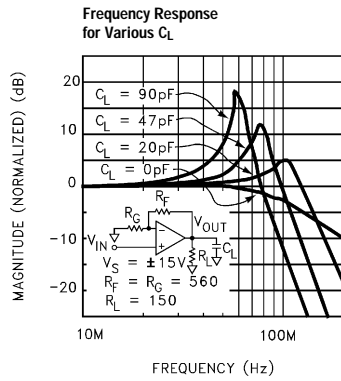

EL2160C

180MHz Current Feedback Amplifier

EL2160C

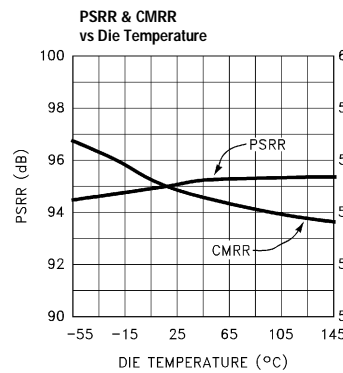
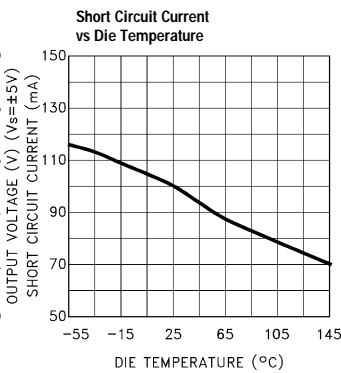
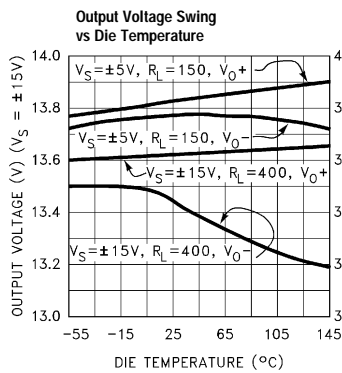
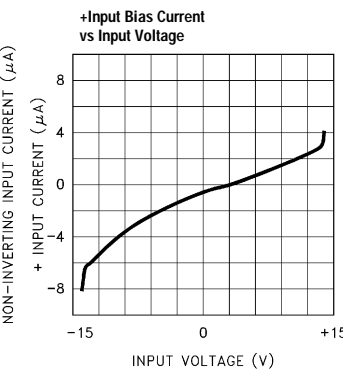
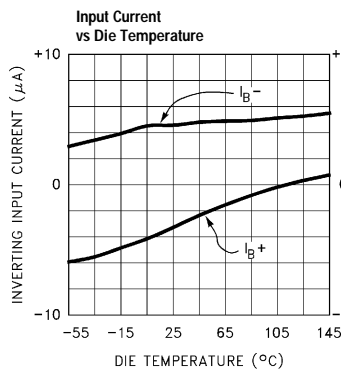
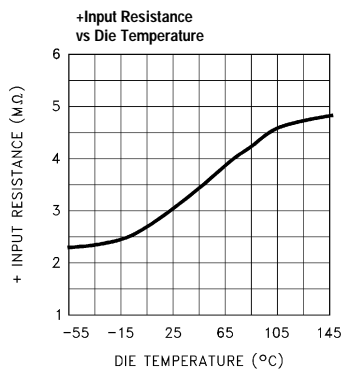
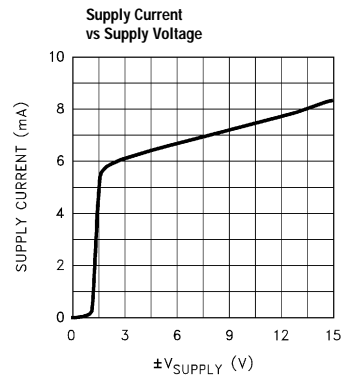
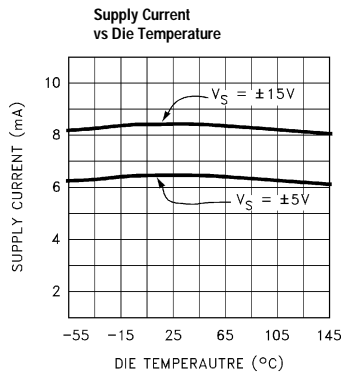
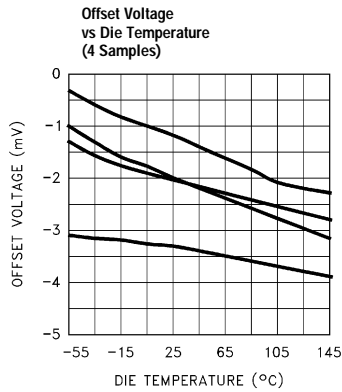

EL2160C

180MHz Current Feedback Amplifier

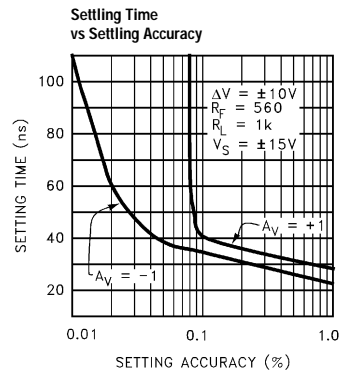
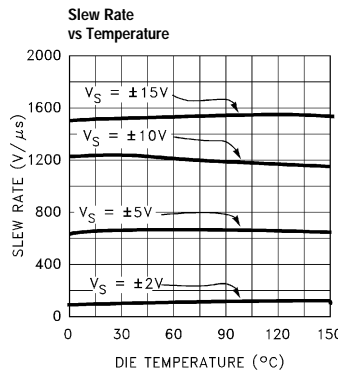
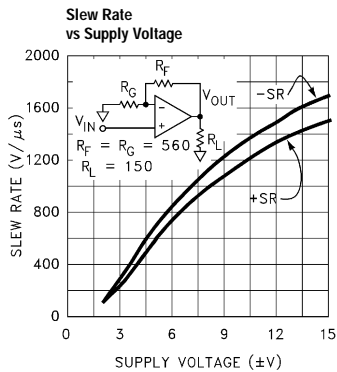
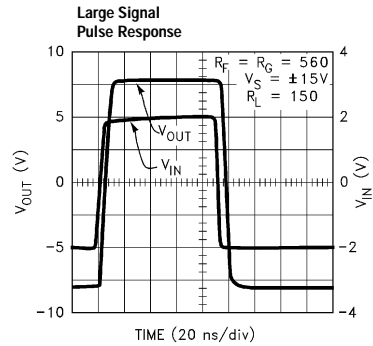
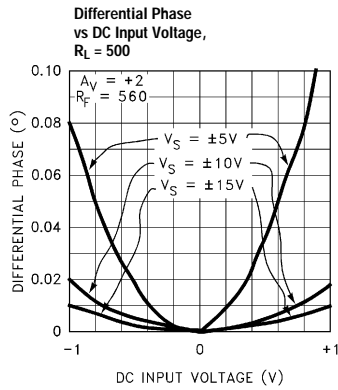
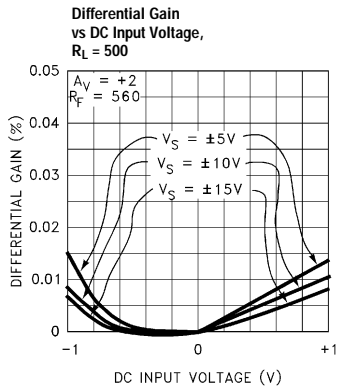
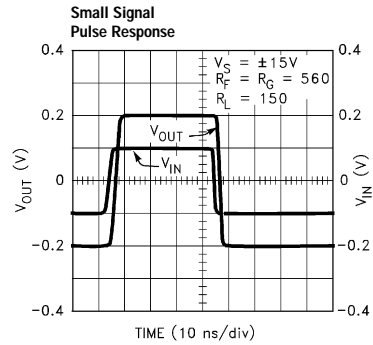
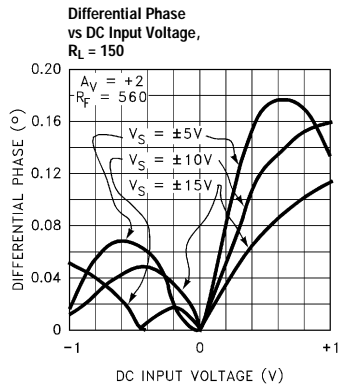
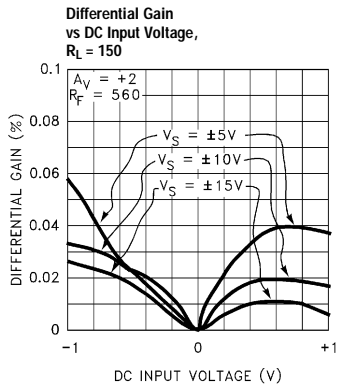

EL2160C

180MHz Current Feedback Amplifier

EL2160C

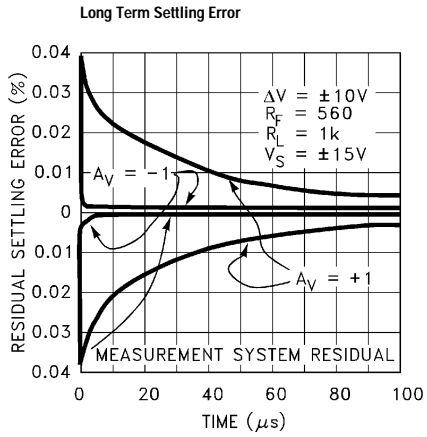

POWER DISSIPATION (W)

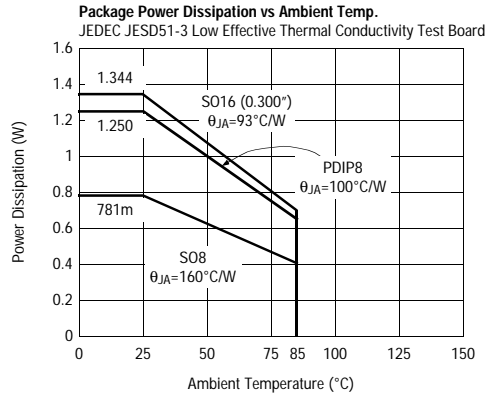

Burn-In Circuit

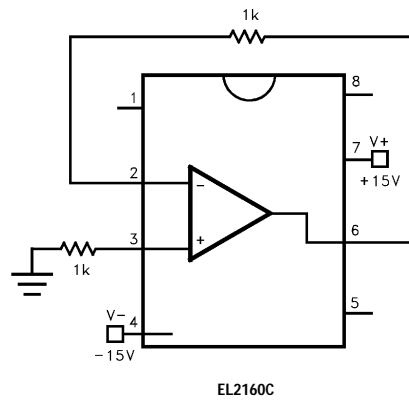

EL2160C

180MHz Current Feedback Amplifier

Differential Gain and Phase Test Circuit

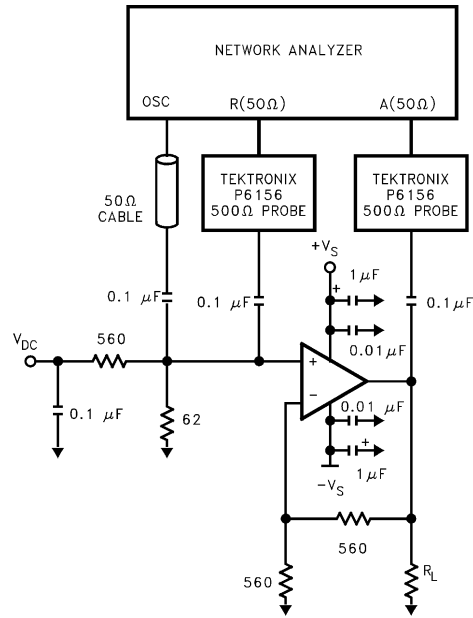

Simplified Schematic (One Amplifier)

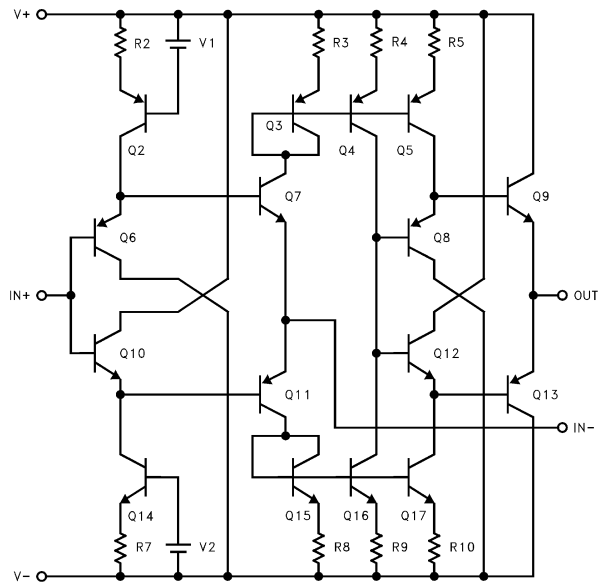

Applications Information

Product Description

The EL2160C is a current mode feedback amplifier that offers wide bandwidth and good video specifications at a moderately low supply current. It is built using Elantec's proprietary complimentary bipolar process and is offered in industry standard pin-outs. Due to the current feedback architecture, the EL2160C closed-loop 3dB bandwidth is dependent on the value of the feedback resistor. First the desired bandwidth is selected by choosing the feedback resistor, R_F , and then the gain is set by picking the gain resistor, R_G . The curves at the beginning of the Typical Performance Curves section show the effect of varying both R_F and R_G . The 3dB bandwidth is somewhat dependent on the power supply voltage. As the supply voltage is decreased, internal junction capacitances increase, causing a reduction in closed loop bandwidth. To compensate for this, smaller values of feedback resistor can be used at lower supply voltages.

Power Supply Bypassing and Printed Circuit Board Layout

As with any high frequency device, good printed circuit board layout is necessary for optimum performance. Ground plane construction is highly recommended. Lead lengths should be as short as possible, below $\frac{1}{4}$. The power supply pins must be well bypassed to reduce the risk of oscillation. A $1.0\mu\text{F}$ tantalum capacitor in parallel with a $0.01\mu\text{F}$ ceramic capacitor is adequate for each supply pin.

For good AC performance, parasitic capacitances should be kept to a minimum, especially at the inverting input (see Capacitance at the Inverting Input section). This implies keeping the ground plane away from this pin. Carbon resistors are acceptable, while use of wire-wound resistors should not be used because of their parasitic inductance. Similarly, capacitors should be low inductance for best performance. Use of sockets, particularly for the SO package, should be avoided. Sockets add parasitic inductance and capacitance which will result in peaking and overshoot.

Capacitance at the Inverting Input

Due to the topology of the current feedback amplifier, stray capacitance at the inverting input will affect the AC and transient performance of the EL2160C when operating in the non-inverting configuration. The characteristic curve of gain vs. frequency with variations of C_{IN-} emphasizes this effect. The curve illustrates how the bandwidth can be extended to beyond 200MHz with some additional peaking with an additional 2pF of capacitance at the V_{IN-} pin for the case of $A_V = +2$. Higher values of capacitance will be required to obtain similar effects at higher gains.

In the inverting gain mode, added capacitance at the inverting input has little effect since this point is at a virtual ground and stray capacitance is therefore not "seen" by the amplifier.

Feedback Resistor Values

The EL2160C has been designed and specified with $R_F=560\Omega$ for $A_V = +2$. This value of feedback resistor yields extremely flat frequency response with little to no peaking out to 130MHz. As is the case with all current feedback amplifiers, wider bandwidth, at the expense of slight peaking, can be obtained by reducing the value of the feedback resistor. Inversely, larger values of feedback resistor will cause rolloff to occur at a lower frequency. By reducing R_F to 430Ω , bandwidth can be extended to 170MHz with under 1dB of peaking. Further reduction of R_F to 360Ω increases the bandwidth to 195MHz with about 2.5dB of peaking. See the curves in the Typical Performance Curves section which show 3dB bandwidth and peaking vs. frequency for various feedback resistors and various supply voltages.

Bandwidth vs Temperature

Whereas many amplifier's supply current and consequently 3dB bandwidth drop off at high temperature, the EL2160C was designed to have little supply current variations with temperature. An immediate benefit from this is that the 3dB bandwidth does not drop off drastically with temperature. With $V_S = \pm 15\text{V}$ and $A_V = +2$, the bandwidth only varies from 150MHz to 110MHz

EL2160C

180MHz Current Feedback Amplifier

over the entire die junction temperature range of $0^{\circ}\text{C} < T < 150^{\circ}\text{C}$.

Supply Voltage Range

The EL2160C has been designed to operate with supply voltages from $\pm 2\text{V}$ to $\pm 15\text{V}$. Optimum bandwidth, slew rate, and video characteristics are obtained at higher supply voltages. However, at $\pm 2\text{V}$ supplies, the 3dB bandwidth at $A_V = +2$ is a respectable 70MHz. The following figure is an oscilloscope plot of the EL2160C at $\pm 2\text{V}$ supplies, $A_V = +2$, $R_F = R_G = 560\Omega$, driving a load of 150Ω , showing a clean $\pm 600\text{mV}$ signal at the output.

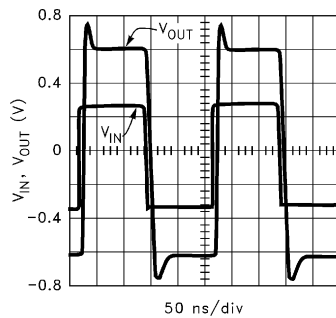

If a single supply is desired, values from $+4\text{V}$ to $+30\text{V}$ can be used as long as the input common mode range is not exceeded. When using a single supply, be sure to either 1) DC bias the inputs at an appropriate common mode voltage and AC couple the signal, or 2) ensure the driving signal is within the common mode range of the EL2160C.

Settling Characteristics

The EL2160C offers superb settling characteristics to 0.1%, typically in the 35ns to 40ns range. There are no aberrations created from the input stage which often cause longer settling times in other current feedback amplifiers. The EL2160C is not slew rate limited, therefore any size step up to $\pm 10\text{V}$ gives approximately the same settling time.

As can be seen from the Long Term Settling Error curve, for $A_V = +1$, there is approximately a 0.035% residual which tails away to 0.01% in about $40\mu\text{s}$. This is a thermal settling error caused by a power dissipation

differential (before and after the voltage step). For $A_V = -1$, due to the inverting mode configuration, this tail does not appear since the input stage does not experience the large voltage change as in the non-inverting mode. With $A_V = -1$, 0.01% settling time is slightly greater than 100ns.

Power Dissipation

The EL2160C amplifier combines both high speed and large output current drive capability at a moderate supply current in very small packages. It is possible to exceed the maximum junction temperature allowed under certain supply voltage, temperature, and loading conditions. To ensure that the EL2160C remains within its absolute maximum ratings, the following discussion will help to avoid exceeding the maximum junction temperature.

The maximum power dissipation allowed in a package is determined by its thermal resistance and the amount of temperature rise according to:

$$P_{\text{DMAX}} = \frac{T_{\text{JMAX}} - T_{\text{AMAX}}}{\theta_{\text{JA}}}$$

The maximum power dissipation actually produced by an IC is the total quiescent supply current times the total supply voltage plus the power in the IC due to the load, or:

$$P_{\text{DMAX}} = 2 \times V_S + (V_S - V_{\text{OUT}}) \times \frac{V_{\text{OUT}}}{R_L}$$

where I_S is the supply current. (To be more accurate, the quiescent supply current flowing in the output driver transistor should be subtracted from the first term because, under loading and due to the class AB nature of the output stage, the output driver current is now included in the second term.)

In general, an amplifier's AC performance degrades at higher operating temperature and lower supply current. Unlike some amplifiers, the EL2160C maintains almost constant supply current over temperature so that AC performance is not degraded as much over the entire operating temperature range. Of course, this increase in performance doesn't come for free. Since the current has increased, supply voltages must be limited so that maximum power ratings are not exceeded.

EL2160C

180MHz Current Feedback Amplifier

EL2160C

The EL2160C consumes typically 8.5mA and maximum 11.0mA. The worst case power in an IC occurs when the output voltage is at half supply, if it can go that far, or its maximum values if it cannot reach half supply. If we set the two $P_{D\text{MAX}}$ equations equal to each other, and solve for V_S , we can get a family of curves for various loads and output voltages according to:

$$V_S = \frac{R_L \times (T_{\text{MAX}} - T_{\text{AMAX}})}{\theta_{JA}} + (V_{\text{OUT}}) + [(2 \times I_S \times R_L) + V_{\text{OUT}}]$$

The following curves show supply voltage ($\pm V_S$) vs R_{LOAD} for various output voltage swings for the 2 different packages. The curves assume worst case conditions of $T_A = +85^\circ\text{C}$ and $I_S = 11\text{mA}$.

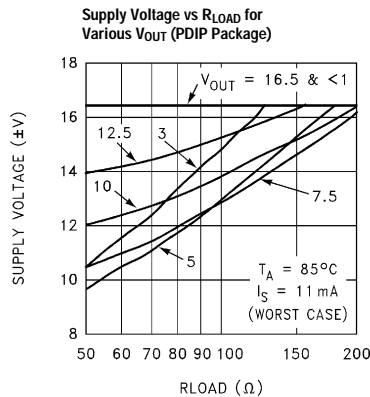
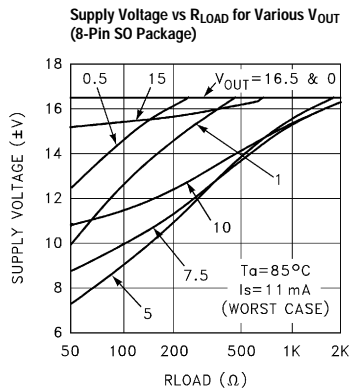

The curves do not include heat removal or forcing air, or the simple fact that the package will probably be attached to a circuit board, which can also provide some form of heat removal. Larger temperature and voltage ranges are possible with heat removal and forcing air past the part.

Current Limit

The EL2160C has an internal current limit that protects the circuit in the event of the output being shorted to ground. This limit is set at 100mA nominally and reduces with junction temperature. At a junction temperature of 150°C , the current limits at about 65mA. If the output is shorted to ground, the power dissipation could be well over 1W. Heat removal is required in order for the EL2160C to survive an indefinite short.

Driving Cables and Capacitive Loads

When used as a cable driver, double termination is always recommended for reflection-free performance. For those applications, the back termination series resistor will decouple the EL2160C from the capacitive cable and allow extensive capacitive drive. However, other applications may have high capacitive loads without termination resistors. In these applications, an additional small value (5Ω – 50Ω) resistor in series with the output will eliminate most peaking. The gain resistor, R_G , can be chosen to make up for the gain loss created by this additional series resistor at the output.

EL2160C**180MHz Current Feedback Amplifier****EL2160C Macromodel**

```

* Revision A, November 1993
* AC Characteristics used CIN- (pin 2) = 1 pF; RF = 560Ω
* Connections:  +input
*               | -input
*               | | +Vsupply
*               | | | -Vsupply
*               | | | | output
*               | | | | |
.subckt EL2160C/EL 3 2 7 4 6
*
* Input Stage
*
e1 10 0 3 0 1.0
vis 10 9 0V
h2 9 12 vxx 1.0
r1 2 11 130
l1 11 12 25nH
iinp 3 0 0.5μA
iinm 2 0 5μA
r12 3 0 2Meg
*
* Slew Rate Limiting
*
h1 13 0 vis 600
r2 13 14 1K
d1 14 0 dclamp
d2 0 14 dclamp
*
* High Frequency Pole
*
*e2 30 0 14 0 0.001666666666
l3 30 17 0.43μH
c5 17 0 0.27pF
r5 17 0 500
*
* Transimpedance Stage
*
g1 0 18 17 0 1.0
ro1 18 0 2Meg
cdp 18 0 2.285pF
*
* Output Stage
*
q1 4 18 19 qp
q2 7 18 20 qn
q3 7 19 21 qn
q4 4 20 22 qp
r7 21 6 4
r8 22 6 4
ios1 7 19 2mA
ios2 20 4 2mA
*
* Supply Current
*
ips 7 4 3mA
*
* Error Terms
*
ivos 0 23 2mA
vxx 23 0 0V
e4 24 0 3 0 1.0
e5 25 0 7 0 1.0

```

EL2160C

180MHz Current Feedback Amplifier

EL2160C

```
e6 26 0 4 0 1.0
r9 24 23 562
r10 25 23 1K
r11 26 23 1K
*
* Models
*
.model qn npn (is=5e-15 bf=100 tf=0.1ns)
.model qp pnp (is=5e-15 bf=100 tf=0.1ns)
.model dclamp d (is=1e-30 ibv=0.266 bv=2.24 n=4)
.ends
```

EL2160C Macromodel

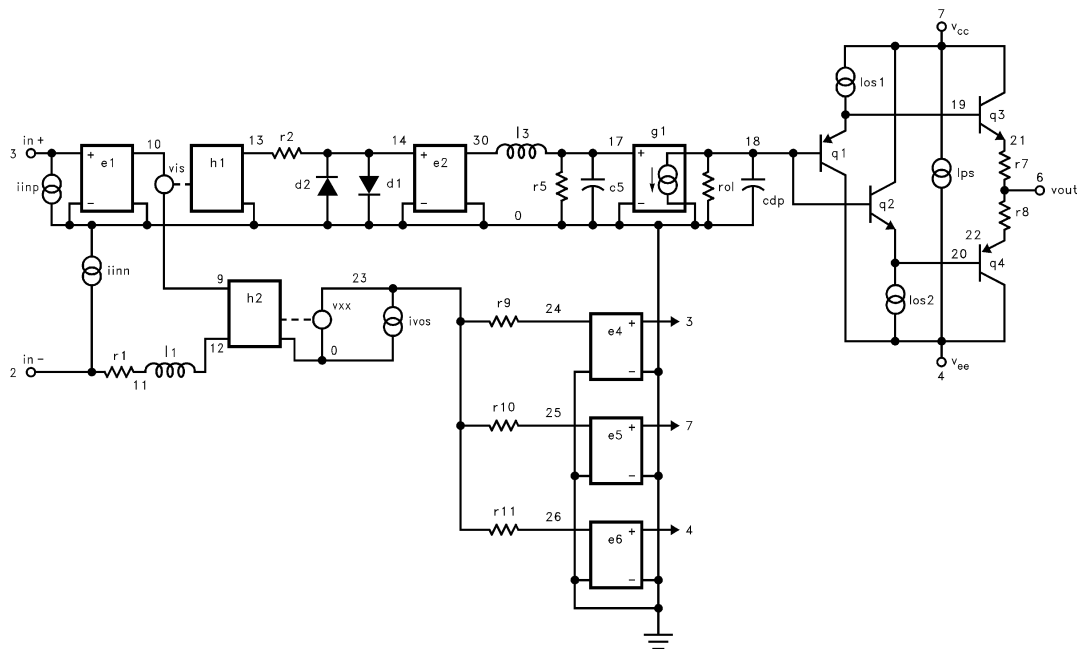

EL2160C

EL2160C

180MHz Current Feedback Amplifier

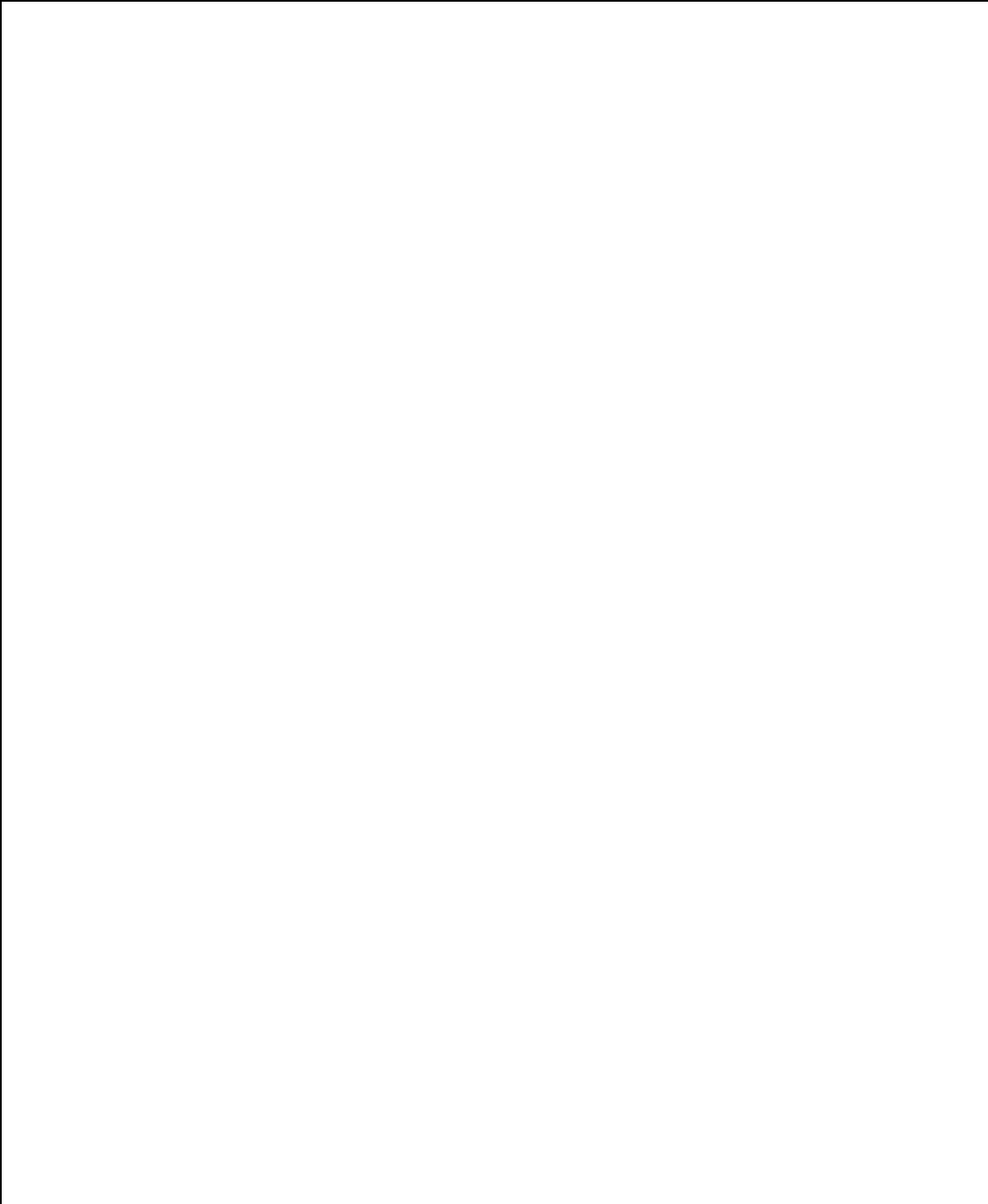

EL2160C
180MHz Current Feedback Amplifier

EL2160C

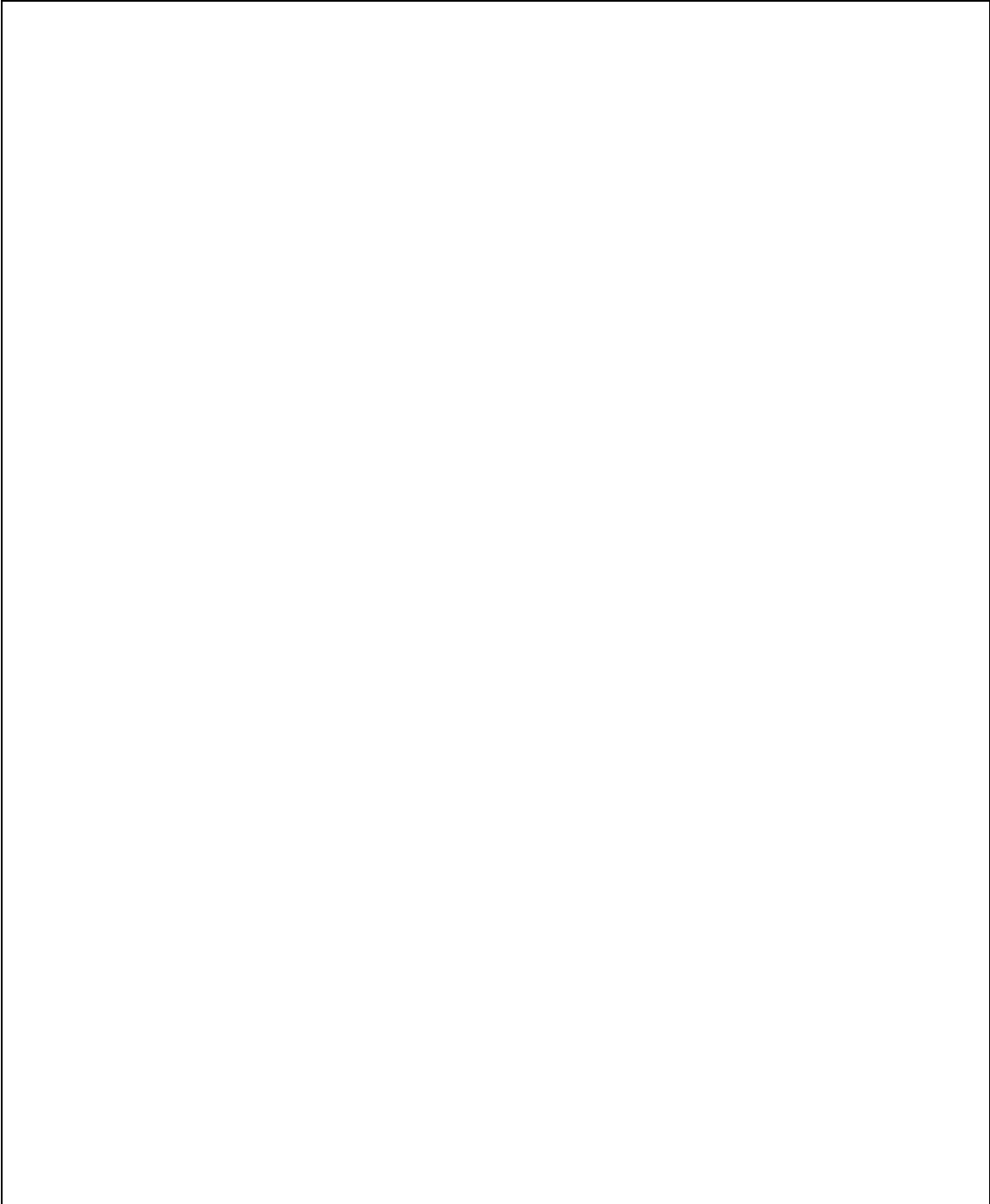

EL2160C*180MHz Current Feedback Amplifier***General Disclaimer**

Specifications contained in this data sheet are in effect as of the publication date shown. Elantec, Inc. reserves the right to make changes in the circuitry or specifications contained herein at any time without notice. Elantec, Inc. assumes no responsibility for the use of any circuits described herein and makes no representations that they are free from patent infringement.

élantec
HIGH PERFORMANCE ANALOG INTEGRATED CIRCUITS

Elantec Semiconductor, Inc.

675 Trade Zone Blvd.
Milpitas, CA 95035
Telephone: (408) 945-1323
(888) ELANTEC
Fax: (408) 945-9305
European Office: +44-118-977-6020
Japan Technical Center: +81-45-682-5820

WARNING - Life Support Policy

Elantec, Inc. products are not authorized for and should not be used within Life Support Systems without the specific written consent of Elantec, Inc. Life Support systems are equipment intended to support or sustain life and whose failure to perform when properly used in accordance with instructions provided can be reasonably expected to result in significant personal injury or death. Users contemplating application of Elantec, Inc. Products in Life Support Systems are requested to contact Elantec, Inc. factory headquarters to establish suitable terms & conditions for these applications. Elantec, Inc.'s warranty is limited to replacement of defective components and does not cover injury to persons or property or other consequential damages.